



SafetyRailCompany

Fall Protection for Life and Compliance



1 1/4" /

SRC ACCU-FIT MOBILE SAFETY RAIL TRADITIONAL SERIES / FALL PROTECTION RAILINGS

DESCRIPTION

The SRC Accu-Fit Mobile Safety Rail system is a non-penetrating, passive fall protection barrier system that protects workers from accidental falls. The Accu-Fit Traditional Series railings take versatility and aesthetics into consideration by utilizing 1 1/4" schedule 40 pipe railings supported by vertical stanchions mounted in weighted cast iron base plates. This system offers a continuous, uniform, vertical railing profile which enhances appearance and is often desirable by clients for use in high traffic areas in view of public.

USES

The SRC Accu-Fit Mobile Safety Rail system is commonly used at unprotected flat roof perimeters of 1:12 pitch or less or any flat, fall from height elevations capable of supporting the railing system.

OSHA COMPLIANCE

- Compliant with OSHA standards: (29 CFR 1910.29 & 29 CFR 1926.502)
- Independently tested by a nationally accredited engineering lab - documentation available upon request

FEATURES

- Provides pleasing site lines and fall protection functionality
- Non-penetrating design will not compromise building envelope
- No welding or drilling required for installation
- American Welding Society Certified (AWS D1.1 & D1.3)
- 100% Made in USA
- Powder coat and galvanized finishes available
- Easily adaptable around obstructions
- Rubber pads are permanently attached to base plate

MINIMUM REQUIREMENTS

- All rail segments along leading edge must begin and end with a 5' (152cm) return rail with base
- Designed for flat and low-sloped roofs, up to a 1:12 roof pitch

DIMENSIONS

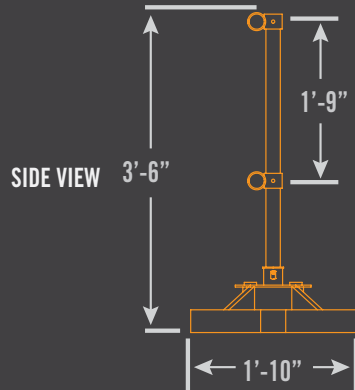

FRONT VIEW



SIZE OPTIONS

Accu-Fit Railing systems consist of three components: Base plate, stanchion and railing pipes. The railing pipes are typically provided in 21' lengths of 1 1/4" sch. 40 galvanized pipe. Pipes are inserted into stanchions and spliced end to end forming a continuous railing profile. Pipe is easily trimmed with power saw at corners or obstructions. This system adapts easily to jobsite conditions and greatly reduces the need for precise pre-measurement of installation site.

ACCU-FIT TRADITIONAL RAIL PROFILE



FINISH OPTIONS



SAFETY YELLOW



GALVANIZED



SAFETY YELLOW
+GALVANIZED



CUSTOM
COLORS

PRODUCT SPECIFICATIONS

- Designed in accordance with OSHA Standards (29 CFR 1910.29 and CFR 1926.502)
- Tested for 200 lb (90.7kg) force in any direction
- Assembled height: 42" (107cm) top rail, 21" (53cm) mid rail
- Cast iron base plates with rubber pads; 104 lbs
- Self-closing gate, optional
- Provides high degree of safety at high risk roof edge areas
- Pleasing sight lines integrate with building architecture
- Variety of finish options available
- 100% Made in USA
- American Welding Society Certified (AWS D1.1 & D1.3)
- All steel construction for longterm durability
- Assemble on-site modular design
- Easily trim railings at corners and obstructions



INSTALLATION

- Using two people, position base plates and insert stanchions into base
- Slide railing pipes into stanch and secure. Trim pipes on corners or terminations
- Estimated install: 120' per hour

PROJECT:

CONTRACTOR:

DATE:

Certified third party OSHA testing results available on request